

TRI COUNTY METALS

2025 PRODUCT CATALOG

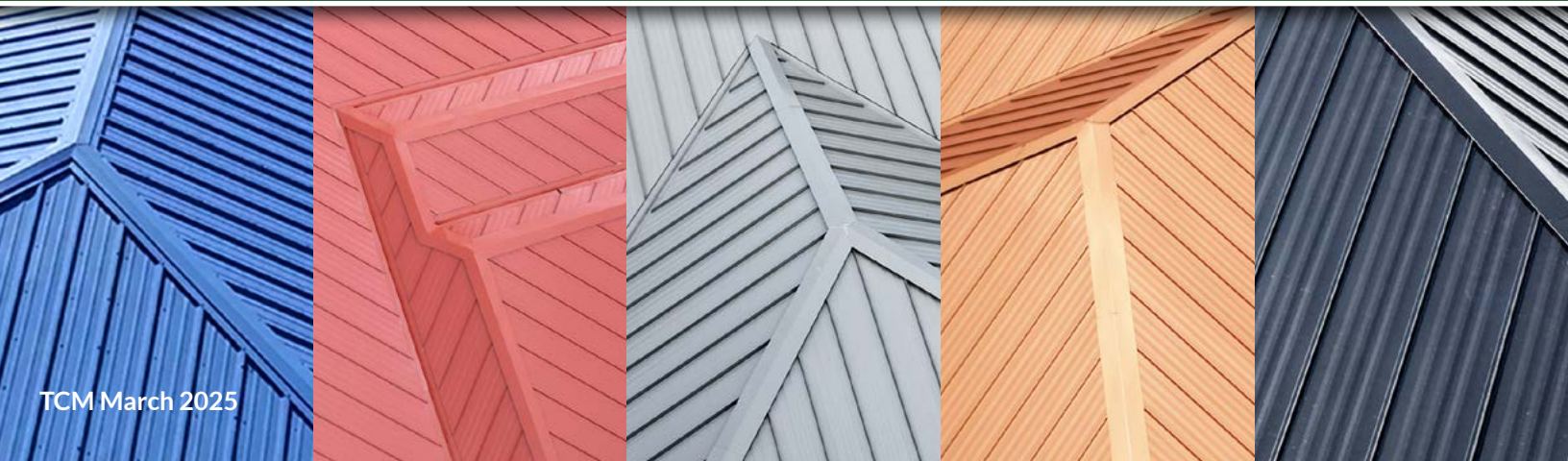

Visit Us Online at [TriCountyMetals.com](https://www.TriCountyMetals.com)



OUR PROVEN PROCESS WILL HELP YOU MAKE MORE MONEY USING THE RESOURCES YOU ALREADY HAVE.

Our team at Tri County Metals has a personal commitment to providing our customers with superior metal roofing products and accessories. We understand how important it can be to have a solid metal roof on your home or business. From personal experience, we have seen how a metal roof can save property and even people during the hurricanes and storms that frequent Florida. We are able to supply you with the roofs, parts, coatings, and accessories you need to keep your property effectively covered.

OUR MISSION STATEMENT:

It is Tri County Metals' mission to safely provide its customers with the knowledge, tools and products to accomplish their projects on time, complete, and at a fair price.

OUR VISION STATEMENT:

- To be a place that team members love coming to work.
- To be a company that customers are delighted doing business with.
- To strive to be excellent at everything that we do.





CHRIS WEATHERILT PRESIDENT

“We are in the business of serving people, through the manufacturing and distribution of metal roofing.”



CONTENTS

- 4 Exposed Fastener Panels Overview
- 5 Standing Seam Panels Overview
- 6 Panel Dimensions
- 7 All TCM Panel Offerings
- 8 Trim - Exposed Fastener
- 9 Trim - Specialty
- 10 Trim - Ultra Rib
- 11 Trim - PBR
- 12 Trim - 5V
- 13 Trim - Standing Seam
- 14 Trim and Clips - Standing Seam
- 15 Ventilation
- 16 Sealants
- 17 Flashings
- 18 Tools
- 20 Fasteners
- 21 Underlayments, Purlins, Doors
- 22 Fastener List
- 23 Order Form



Make Your Next Roof Your Last

Why Tri-County Metals?

We understand what you want most from a metal roofing supplier.

98.3% Order Accuracy

Since January 2020, TCM has been 98.3% on time and complete.

- YTD, 99.85% CAD accuracy (6593 accurate CADs out of 6630 total)
- In 2023, we delivered nearly 14 million items (= units) with 99.994% accuracy.

98.95% Product Quality and Consistency

98.95% of orders delivered without defects in 2024.

- Over the last 5 years, 99.31% of items were delivered without blemish.
- All of our products meet the most stringent HVHZ requirements.
- 1 warranty claim for every 600 roof projects - for more than 15 years

90.7% Fast Delivery Issue Resolution

90.7% of our service recoveries were resolved within 24 hours; (2024 YTD).

- In 2024, 9 out of 10 service issues resolved within 24 hours
- 97.3% of our service recoveries were resolved within 3 days in 2024

9 Branch Locations

With nine Florida locations and growing, chances are good that Tri County Metals has a branch location near you, or we will soon!

- Trenton
- Brooksville
- Jacksonville
- Ocala
- Tallahassee
- Winter Haven
- Live Oak
- Deland
- Okeechobee

170+ Team Members

We have a dedicated team of metal roofing experts, in the field, on the road, and staffing manufacturing at nine statewide locations to make sure your order is on-time and complete – *Every time.*



TRI COUNTY METALS

Installation Highlights and Resources

When it comes to installing metal roofing, we have many resources to help you along the way. The most sought-after resource is our installation guides. We have an installation guide for every metal roofing profile we offer and it is easily accessible online, and hard copies are readily available at our 9 statewide locations.

In addition to installation training, we also have animated installation videos available to view totaling about 20 specific install situations. These short videos will visually walk you through crucial details as you tackle various aspects of installation.

And lastly, we have numerous blog and video resources, like “*Top 10 Install Related Questions Answered*” hosted by David Grimes. These videos are available on our YouTube channel and on our website in our blog section.

Need more help? *No problem!* Our metal roofing experts are just a phone call away!



Visit Our Website

to find an array of Resources, including:

- Project Visualizer
- Product Guide / Catalog
- Product Brochures
- Product Installation Manuals
- Florida Product Approval Documents
- Product Warranty Information
- Blogs



EXPOSED FASTENER PANELS

The Ultra Rib is the main-stay, go-to metal roofing panel for many projects. The biggest difference with the Ultra Rib compared to other popular panels is it is fastened to the roof with fasteners that can be seen. This is called an “exposed” metal roofing panel.

Looking for a classic, Florida-Cracker, or Key West look for your home? Then our 5V metal roofing panel is the panel for you. This exposed metal roofing fastener is currently available in Galvalume™ finish.

Note: This profile is available in striated or flat. Striated shown and recommended.

For low-slope, commercial, or agricultural applications, the PBR panel is a rugged metal roofing panel that can get the job done. Available in many Core Defender colors, the PBR panel definitely has its place in our metal roofing panel line up.



ULTRA RIB



Our most popular exposed fastener panel is perfect for residential re-roof applications. This panel is manufactured in our facility. Suitable for any roof with a pitch greater than 2:12.

- Applications: Residential, Agricultural, Light Commercial, Industrial
- Gauge: 26 gauge and 29 gauge Residential, Agricultural, Light Commercial, Industrial
- Panel Profile: 36” Net coverage, 5 ribs 9” On-Center, 3/4” high rib
- Substrate: Steel
- Finish: Siliconized Modified Polyester. Acrylic coated Galvalume® AZ55

PBR



PBR (also referred to as the “R” panel) is a standard, agricultural and light commercial exposed fastener panel. This panel is manufactured in our facility. Suitable for any roof with a pitch greater than 0.5:12.

- Applications: Residential, Agricultural, Light Commercial, Industrial
- Gauge: 26 gauge, and 24 gauge (24 GA mill finish only at this time.)
- Panel Profile: 36” Net Coverage, 4 ribs 12” On-Center, 1.25” high rib
- Substrate: Steel
- Finish: Siliconized Modified Polyester. Acrylic coated Galvalume® AZ55

5V

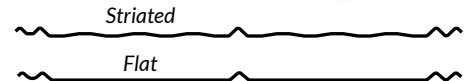

5V Metal Roofing panels have a classic look similar to one of the oldest profiles on the market.

- Applications: Residential, Agricultural
- Gauge: 26 gauge 24 gauge, or 0.32 Aluminum
- Panel Profile: 24” Net Coverage
- Substrate: Steel or Aluminum
- Finish: Acrylic coated Galvalume® AZ55, SMP, and Kynar

Explore All of Our Exposed Fastener Panels



All of TCM's Panels are Florida HVHZ Approved



As of March 2025, most of our panels have also received **Miami-Dade County's** stringent **NOA** approval.

See chart on page 7.





STANDING SEAM PANELS

Tri County Metals offers a robust line up of standing seam panels suitable for both residential and commercial projects. With full product approvals including HVHZ, fast production and delivery speed, we can meet your needs.

*Explore All of Our
Standing Seam Panels*



TCM-LOK

Would you rather not see the fasteners like you would with an exposed metal roofing panel? For many residential applications, the TCM-LOK panel may be for you. This panel is manufactured with an incorporated “nail strip” for fastening directly to the roof deck. TCM-LOK is available in all three color systems. This panel is available in both steel and aluminum.

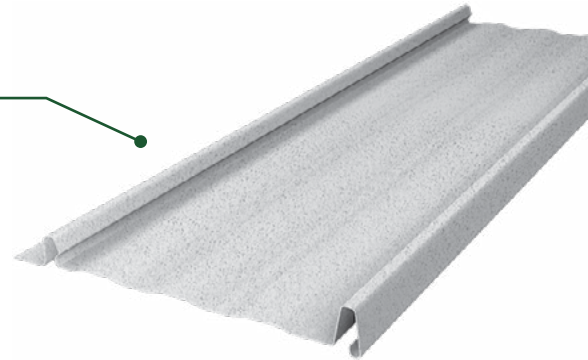

SL-LOK

Do you like the idea of a standing seam panel with hidden fasteners, but have a home or project that will require a panel run of more than 30 feet? Then you'll want to consider our SL-LOK panel profile. The “SL” stands for “snap lock” and refers to how the panel ribs snap together during installation. With a handsome higher rib at 1.5”, the SL-LOK is attached using a fixed clip system, or our TCM Continuous Clip which is a great consideration for high design pressure needs.

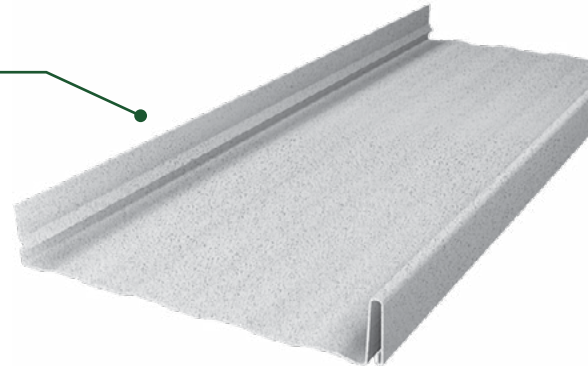

SS-LOK

Similar to the SL-LOK as related to the attachment method and style, our SS-LOK panel has a more pronounced 1.75” rib, and is also attached using a clip system. Ideal for longer runs and commercial applications, this panel is available in Sherwin-Williams Fluorpon industrial coil coatings.

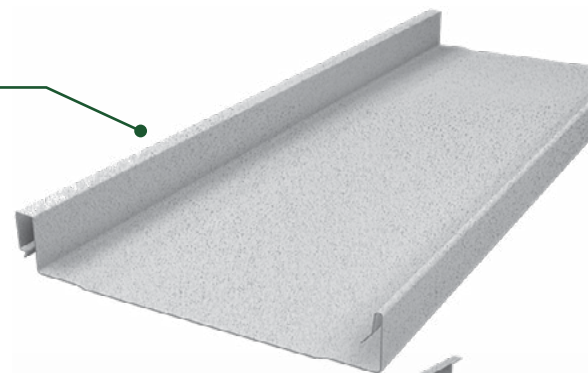

MS-LOK

Do you have a commercial project or a larger home that calls for a pronounced, higher rib? The MS-LOK panel is a standing seam panel that requires a special folding machine to overlap and seal the seam – thus why you see “MS” or “mechanical seam” in the name. This panel is often the panel of choice for commercial projects.

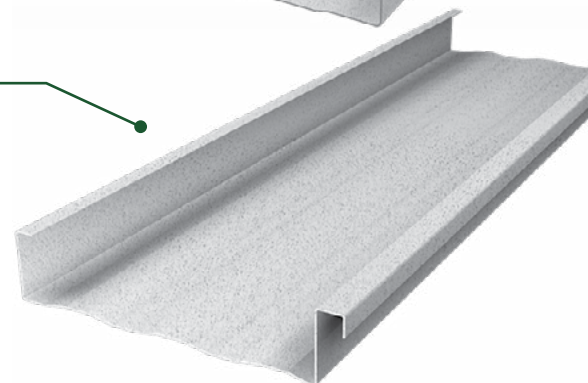

PANEL DIMENSIONS

ULTRA RIB

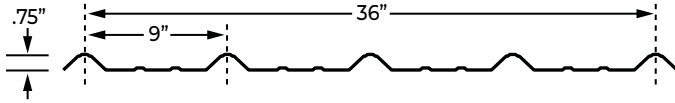

PBR

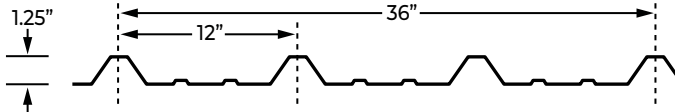

5V

Available in striated or flat.

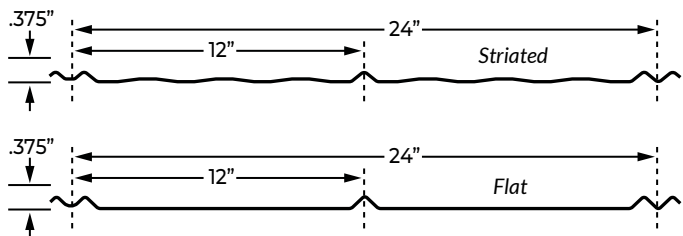

TCM-LOK

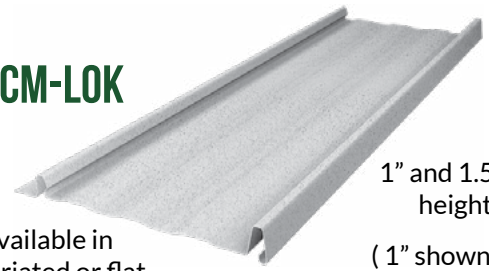

Available in striated or flat.

1" and 1.5" heights
(1" shown)

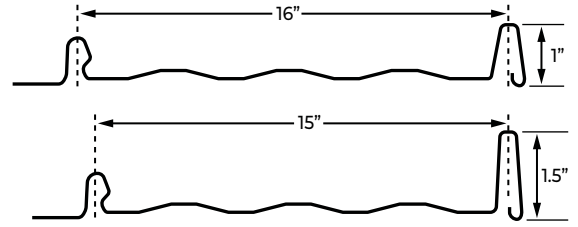

SL-LOK



Available in striated or flat.

1.5" height

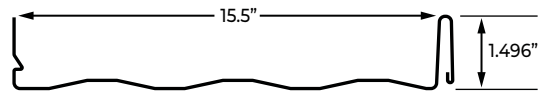

SS-LOK

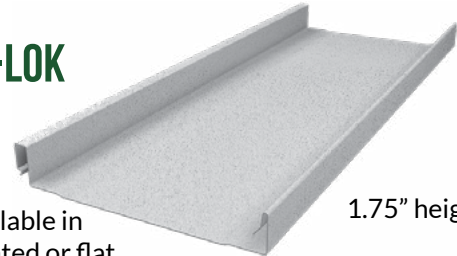

Available in striated or flat.

1.75" height

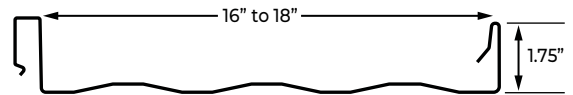

MS-LOK



Available in striated or flat.

1.5" and 2" heights
(2" shown)

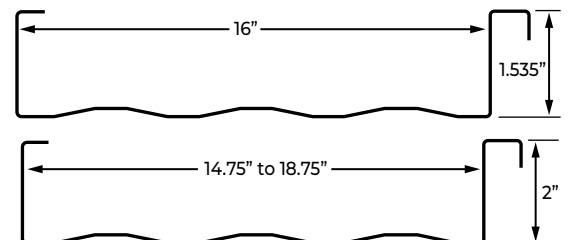

Explore Product Brochures





OUR COMPLETE PANEL OFFERINGS

	EXPOSED FASTENER PANELS			STANDING SEAM PANELS						
	ULTRA RIB	PBR	5V	TCM-LOK 1"	TCM-LOK 1 1/2"	SL-LOK 1 1/2"	SS-LOK 1 3/4"	MS-LOK 1 1/2"	MS-LOK 2"	
RESIDENTIAL	✓	✓	✓	✓	✓	✓	✓	✓	✓	✓
COMMERCIAL	✓	✓	✓	✓	✓	✓	✓	✓	✓	✓
AGRICULTURAL	✓	✓	✓	✓	✓	✓	✓	✓	✓	✓
GAUGE OF ALUMINUM SUBSTRATE			.032	.032		.032	.040			
GAUGE OF STEEL SUBSTRATE	29, 26	26, 24	26, 24	26, 24	24	24	24	24	24	24
MAX OR COASTAL DEFENDER			✓	✓	✓	✓	✓	✓	✓	✓
CORE DEFENDER (SMP)	✓	24GA GALV ONLY ✓	✓	✓						
MINIMUM SLOPE	2:12	0.5:12	2:12	0.25:12	0.25:12	0.25:12	0.25:12	0.25:12	0.25:12	0.25:12
SUPPORT	WOOD DECK OPEN FRAMING	WOOD DECK STEEL DECK OPEN FRAMING	WOOD DECK	WOOD DECK	WOOD DECK	WOOD DECK	WOOD DECK	WOOD DECK STEEL DECK	WOOD DECK STEEL DECK OPEN FRAMING	
RIB HEIGHT	0.75"	1.25"	0.375"	1.0"	1.5"	1.5"	1.75"	1.5"	2.0"	
COVERAGE	36"	36"	24"	16"	15"	15.5"	18" 24GA 16" .040	16"	14.75" 18.75"	
CUSTOM LENGTHS	✓	✓	✓	✓	✓	✓	✓	✓	✓	✓
MAX PANEL LENGTH <small>NOTE: MINIMUM LENGTH FOR ALL IS 3'</small>	45' <small>53' IF OUTSIDE TRANSPORT USED</small>	45'	45'	35'	35'	55' <small>35' AND UP, ONSITE ONLY</small>	55' <small>35' AND UP, ONSITE ONLY</small>	55' <small>35' AND UP, ONSITE ONLY</small>	55' <small>35' AND UP, ONSITE ONLY</small>	55' <small>35' AND UP, ONSITE ONLY</small>
STRIATED, RIBBED, OR FLAT			✓ <small>STRIATED OR FLAT ONLY</small>	✓	✓	✓	✓	✓	✓	✓
ON-SITE PRODUCTION AVAILABLE			✓	✓	✓	✓	✓	✓	✓	✓
FLORIDA PRODUCT APPROVAL *	✓	✓	✓	✓	✓	✓	✓	✓	✓	✓
 HVHZ APPROVAL *	✓	✓	✓	✓	✓	✓	✓	✓	✓	✓
 NOA APPROVAL *	✓	✓	✓	✓		✓		✓		

*Note: You can find the most current Florida Product Approval information for all of our metal roofing panels on our website: TriCountyMetals.com

TRIM REFERENCE | ALL EXPOSED FASTENER



This page contains all the common, standard trim that are **uniform in measurement** for Ultra Rib, PBR and 5V profiles. All trim 26 GA as standard when ordered.

► All trim sold in 10ft lengths.

► A / B Labels used for Specialty Trim custom modifications.

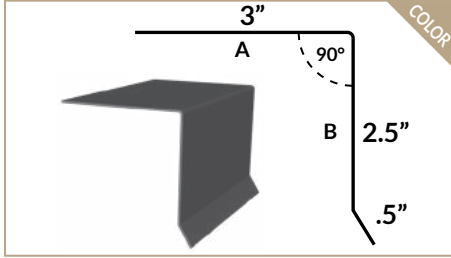

DRIP EDGE

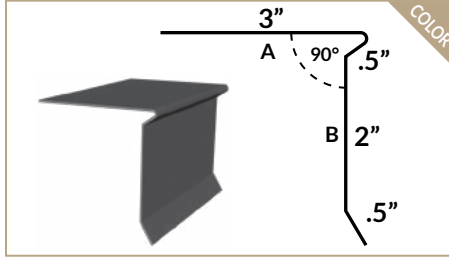

FHA DRIP

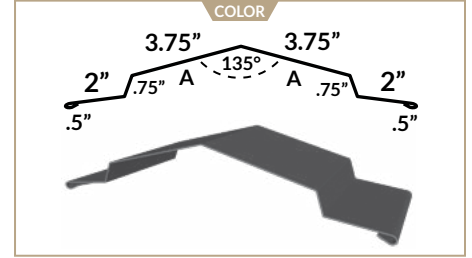

RIDGE CAP

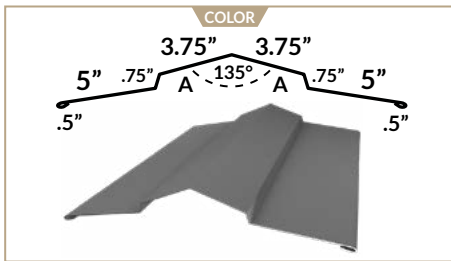

LARGE RIDGE CAP

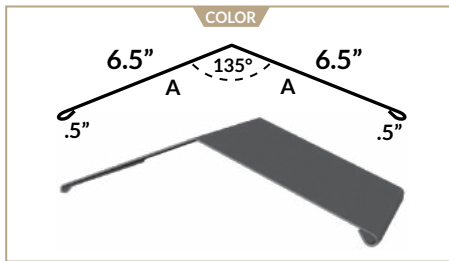

FLAT RIDGE CAP / HIP CAP FLAT

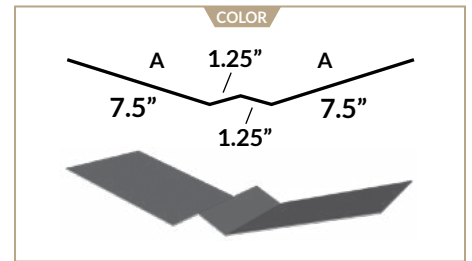

W-VALLEY

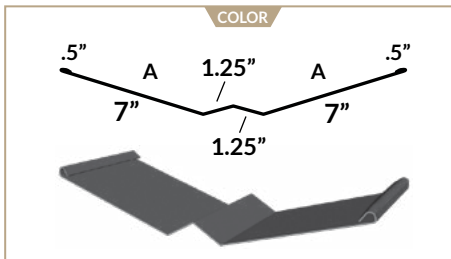

HEMMED W-VALLEY

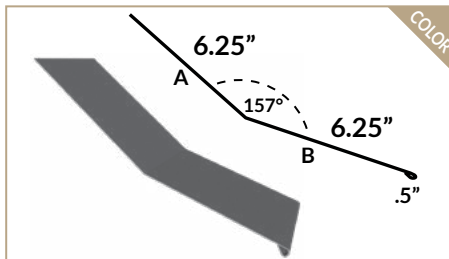

TRANSITION

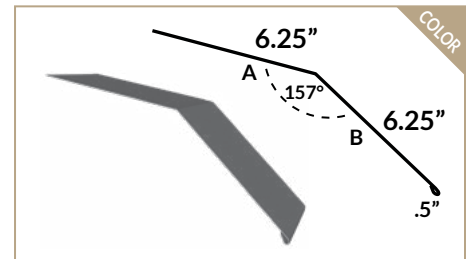

GAMBREL

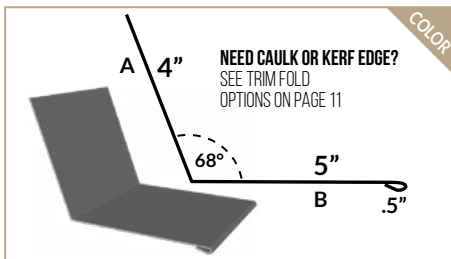

FLAT ENDWALL

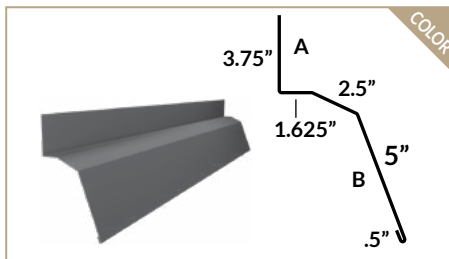

SLIDING TRACK COVER

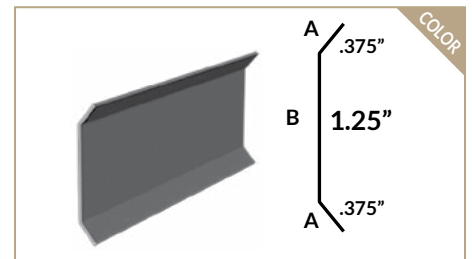

COUNTER FLASHING

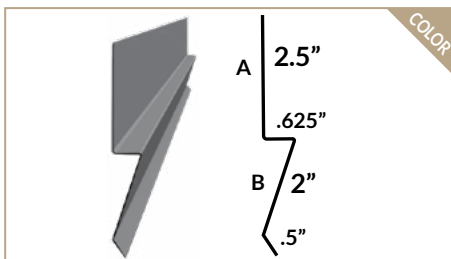

STUCCO STOP

All of the trim on this page are standard items, and the measurements across all Exposed Fastener profiles are identical for all 3 profiles. If the trim you need isn't on this page, look in the Trim Reference by Panel on pages 10-12.

Need help? Just call 877-766-3309.

TRIM REFERENCE | SPECIALTY TRIM

Don't forget these
essential items for
weatherproofing and ventilation:

6" Peel and Seal
for Hip Caps

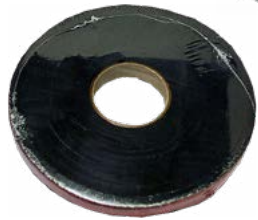

Expanding
Foam for
W-Valleys

BuytI Tape
(Tacky Tape)
for overlaps
and gable



Snap-Z



Flex Pro

Tri County Metals can manufacture special trim designs separate from those designs included in the manual. If your project requires special trim, please provide us with the following information:

1. A drawing of the trim design.
2. Clearly marked dimensions of each leg of the drawing.
3. Clearly marked degrees of each angle.
4. Clearly indicate the color side.

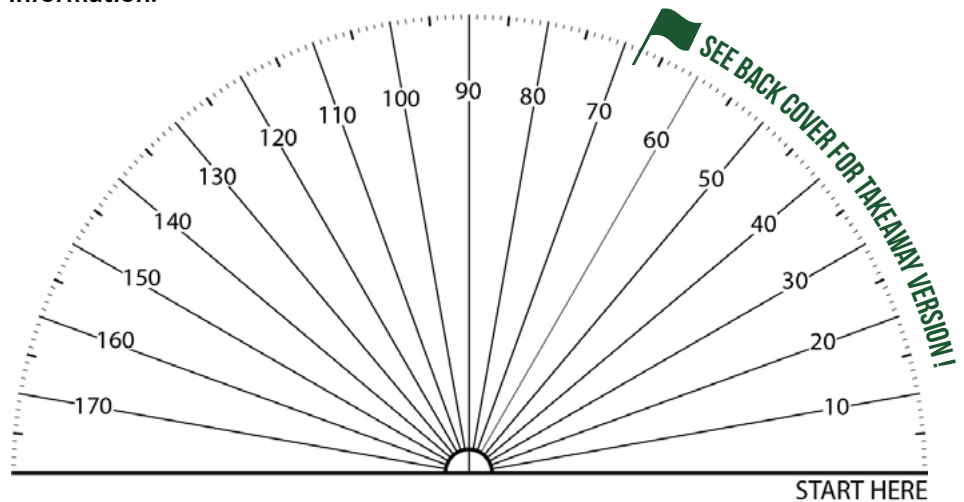

These two trim pieces need to have measurements for each leg, and color side verified with each order.

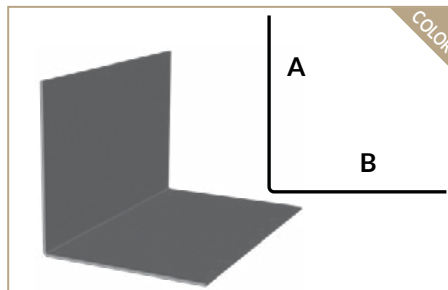

L FLASHING

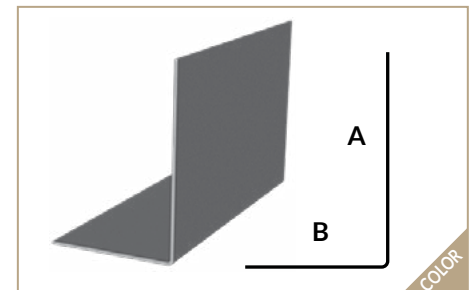

FASCIA

TRIM MANUFACTURING SPECIFICATIONS

- Hem size must be .5" or larger.
- Bends on hemmed legs need to be greater than .5" or else the hem obstructs the break.
- Smashed parts need to be at least 1.25".
- Maximum bend break can do is 135 degrees.
- When bending angles opposite of one another, like that of a Z Flashing, the middle part of the Z must be at least .5" or larger.
- When bending two 90 degree bends on the same side, one leg has to be equal to or less than the length of the material between the two bends.
- Pieces with more than two bends on the same side are difficult to do unless the bends are large enough. Please talk with a Tri County Metals representative for assistance.
- For trim pieces that have to slide over another piece where the inside dimensions are critical, please indicate "CRITICAL" measurement.
- Indicate open or closed hems. Unless specified, the hem will be open.
- Standing seam = open hem
Exposed profile = closed hem

TRIM REFERENCE | ULTRA RIB, SPECIFIC



This page contains all the stock trim specific to the Ultra Rib profile.

- ▶ All trim sold in 10ft lengths.
- ▶ A / B Labels used for Specialty Trim custom modifications.

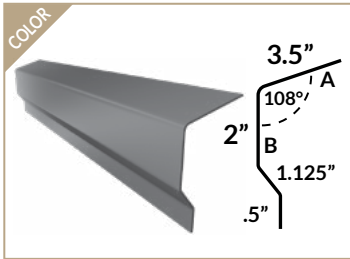

DRIP COVER

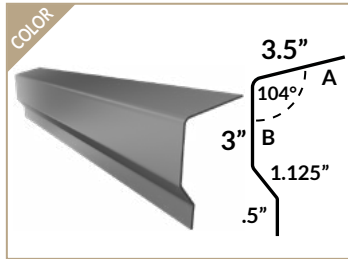

DRIP COVER (WITH PURLINS)

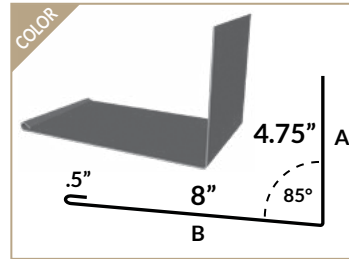

CHIMNEY FLASHING

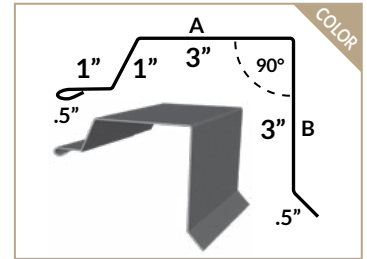

GABLE

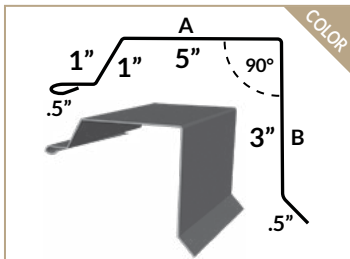

LARGE GABLE TRIM

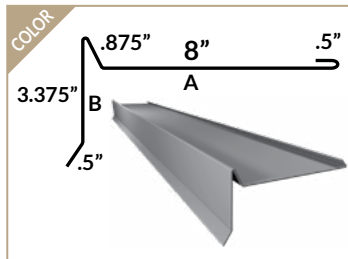

FLYING GABLE

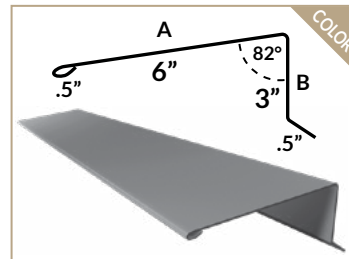

HIGH SIDE RIDGE CAP

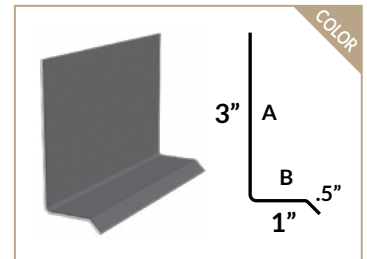

DRIP CAP

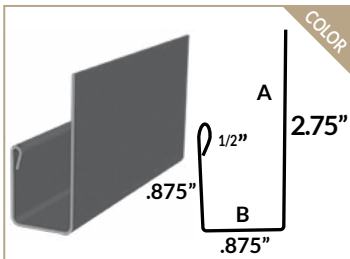

J CHANNEL

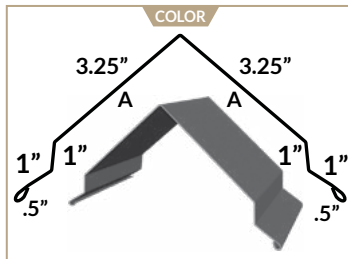

OUTSIDE CORNER

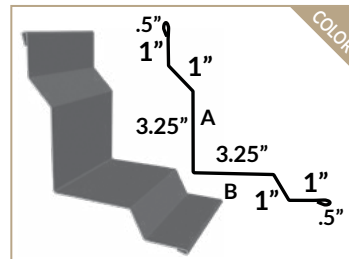

INSIDE CORNER

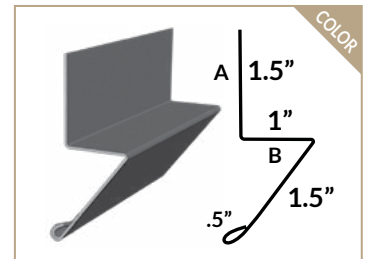

BASE ANGLE

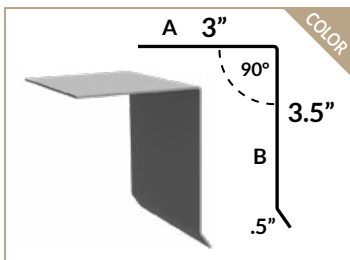

LARGE FACE DRIP EDGE

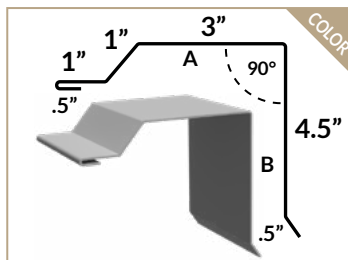

LARGE FACE GABLE TRIM

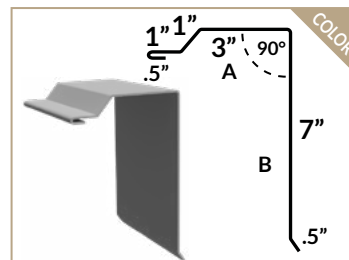

BARN GABLE TRIM

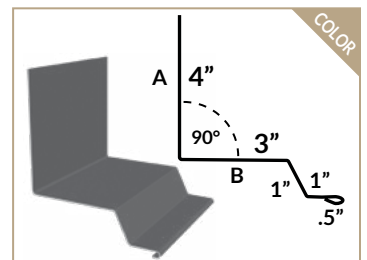

SIDEWALL

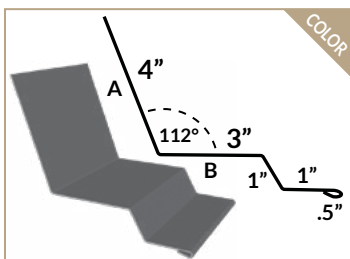

ENDWALL



Are you not finding the trim you need on this page?

It's possible the trim you are looking for is a standard Exposed Fastener trim item. Many trim across our Exposed Fastener panel offerings have uniform measurements, you can find all of those trim on **Page 8**. Otherwise, we can help you with a specialty trim order to meet your project needs.



TRIM REFERENCE | PBR, SPECIFIC



This page contains all the stock trim specific to the PBR profile.

- ▶ All trim sold in 10ft lengths.
- ▶ A / B Labels used for Specialty Trim custom modifications.

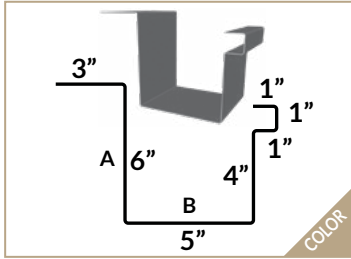

BOX GUTTER

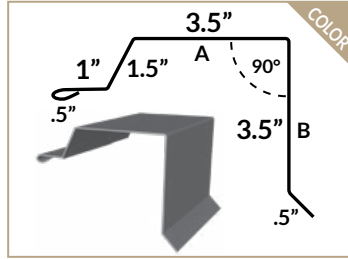

PBR GABLE

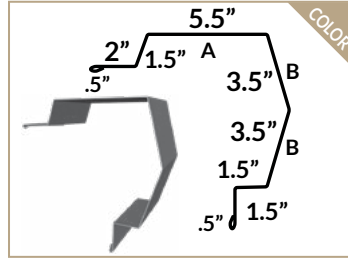

SCULPTURED RAKE

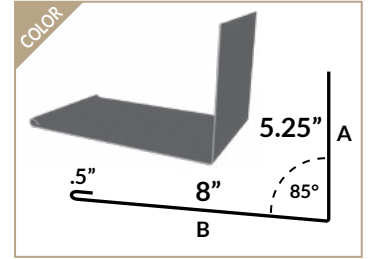

PBR CHIMNEY FLASHING

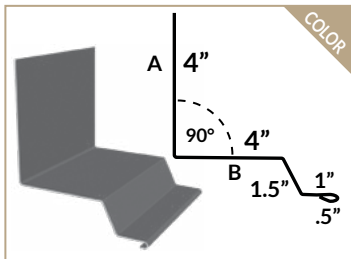

PBR SIDEWALL

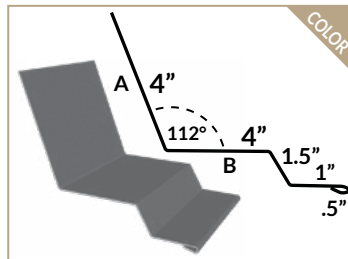

PBR ENDWALL

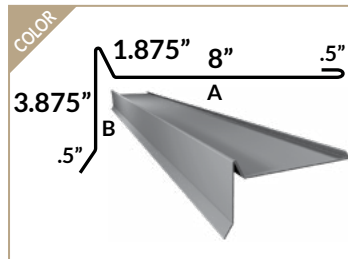

FLYING GABLE

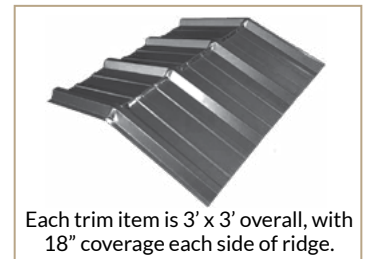

Each trim item is 3' x 3' overall, with 18" coverage each side of ridge.

DIE FORMED RIDGE CAP

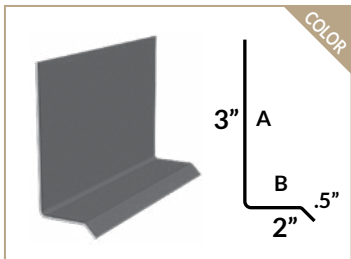

PBR DRIP CAP

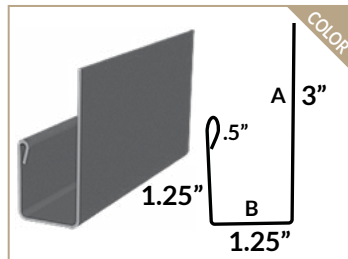

PBR J CHANNEL

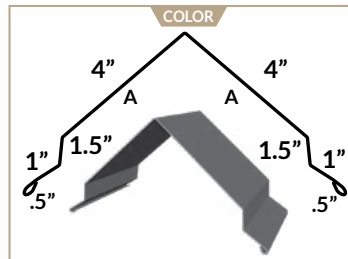

PBR OUTSIDE CORNER

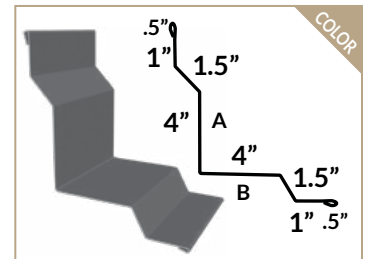

PBR INSIDE CORNER

§ OPTIONS

Please be sure to specify if a caulk edge or kerf edge is needed with sidewall or endwall trim as needed for your specific project.

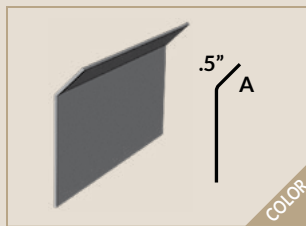

CAULK EDGE

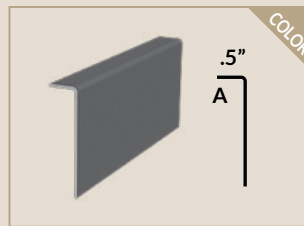

KERF EDGE

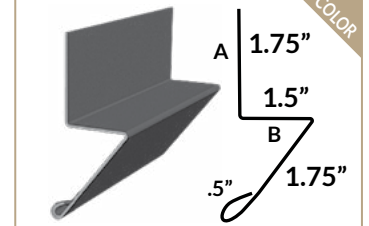

PBR BASE ANGLE

Before you order:

For a successful final result, it is critical that you verify the panel lengths on your estimate prior to our team finalizes your order. Be sure to include Peel and Seal for Hip Caps, Expanding Foam for your W-Valleys, and Tacky Tape for laps and weathertight installation for most trim. Our team can help! Give us a call and we will walk you through the details to be sure you have everything needed as your order is finalized.

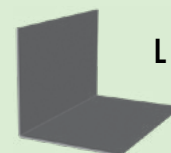

L FLASHING

Looking for **L FLASHING** or **FASCIA** info?

Please see page 9 for details.



FASCIA

TRIM REFERENCE | 5V, SPECIFIC



This page contains all the stock trim specific to the 5V profile.

► All trim sold in 10ft lengths.

► A / B Labels used for Specialty Trim custom modifications.

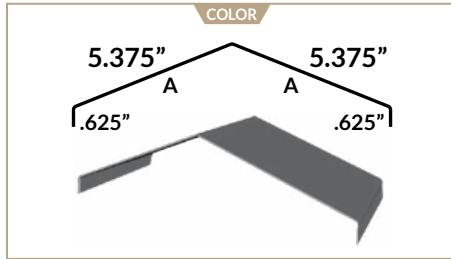

5V RIDGE / HIP CAP

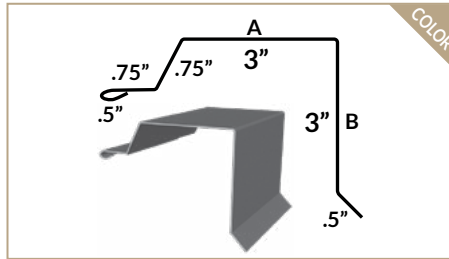

5V GABLE

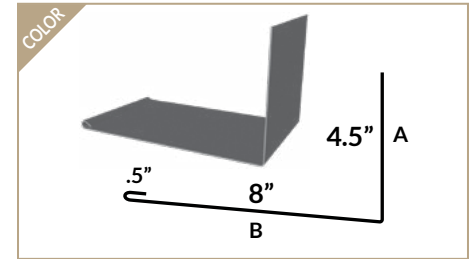

5V CHIMNEY FLASHING

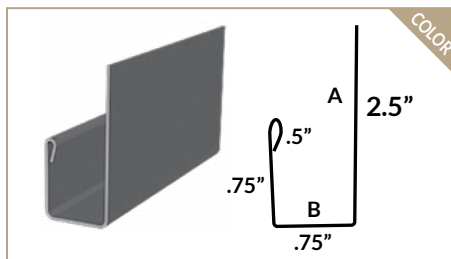

5V J CHANNEL

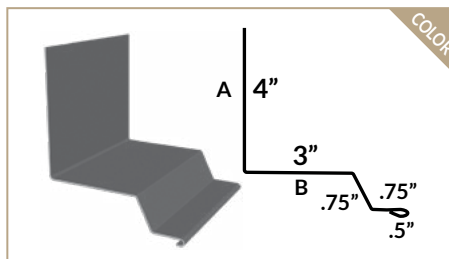

5V SIDEWALL

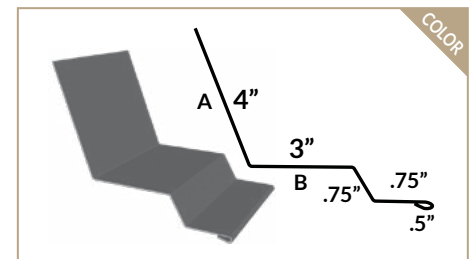

5V ENDWALL



Are you not finding the trim you need on this page?

It's possible the trim you are looking for is a standard Exposed Fastener trim item. Many trim across our Exposed Fastener panel offerings have uniform measurements, you can find all of those trim on **Page 8**. Otherwise, we can help you with a specialty trim order to meet your project needs.

Before you order:

For a successful final result, it is critical that you verify the panel lengths on your estimate prior to our team finalizes your order. Be sure to include Peel and Seal for Hip Caps, Expanding Foam for your W-Valleys, and Tacky Tape for laps and weathertight installation for most trim. Our team can help! Give us a call and we will walk you through the details to be sure you have everything needed as your order is finalized.

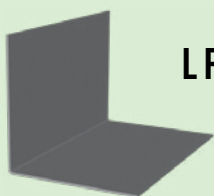

L FLASHING

Looking for
L FLASHING or **FASCIA** info?

Please see page 9
for details.



FASCIA

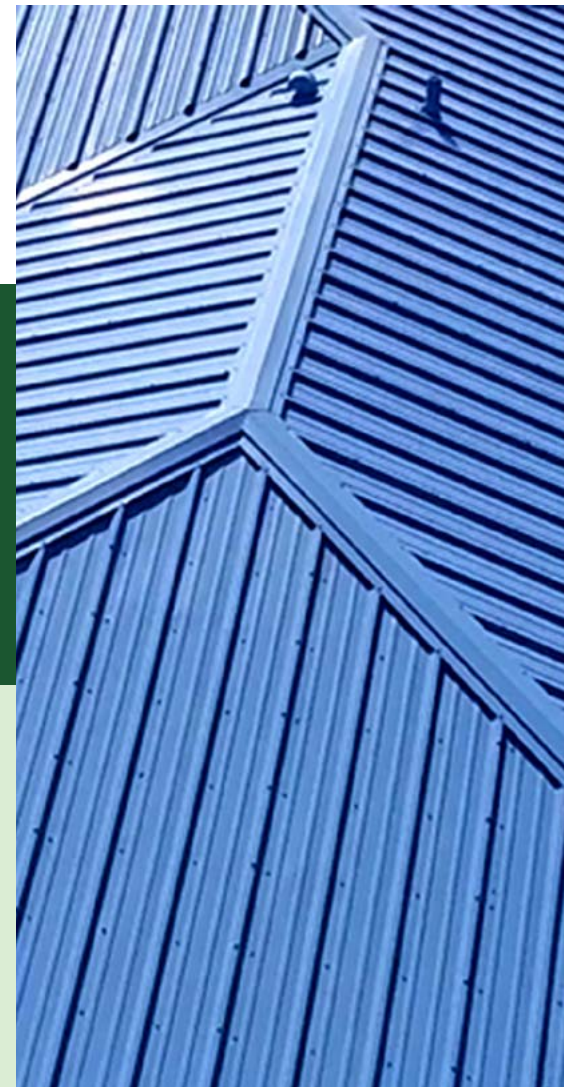

TRIM REFERENCE | STANDING SEAM



This page contains all the standard trim specific to the TCM-LOK, MS-LOK, and SL-LOK profiles.

- ▶ All trim sold in 10ft lengths.
- ▶ A / B Labels used for Specialty Trim custom modifications.

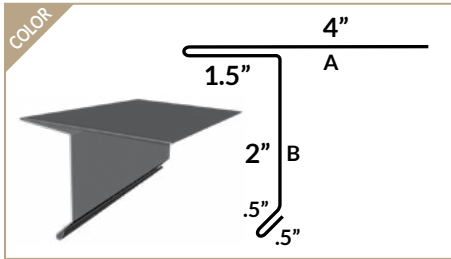

DRIP EDGE

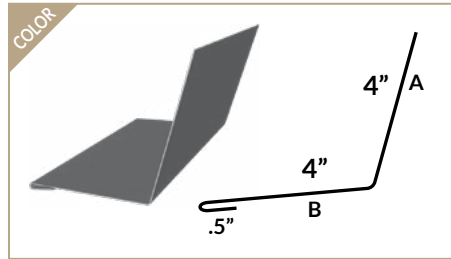

ENDWALL

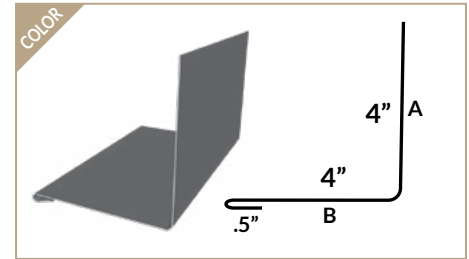

SIDEWALL

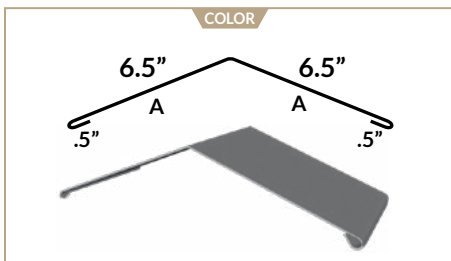

TCM-LOK FLAT RIDGE / HIP

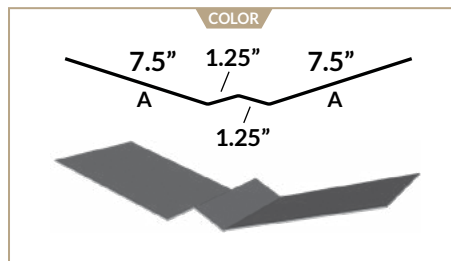

W-VALLEY

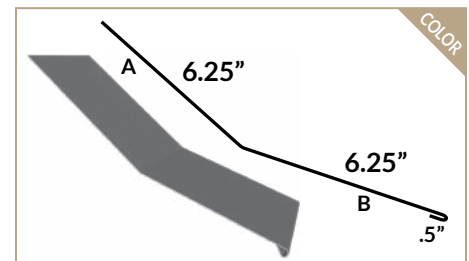

TRANSITION

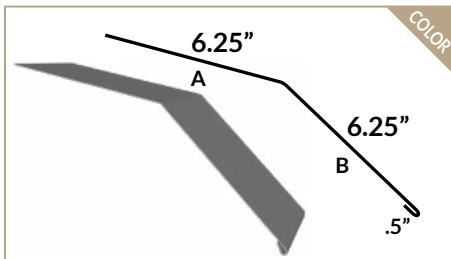

GAMBREL

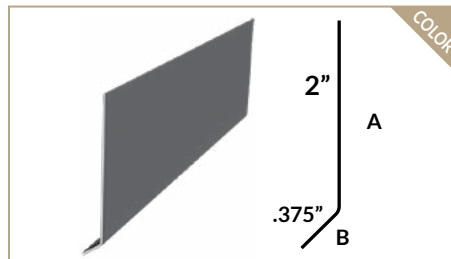

EAVE CLEAT

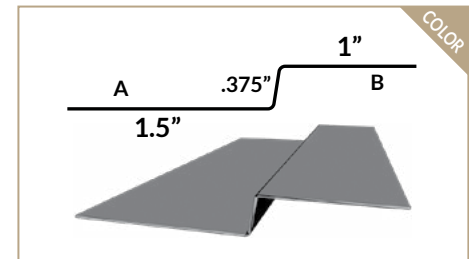

PANEL STARTER

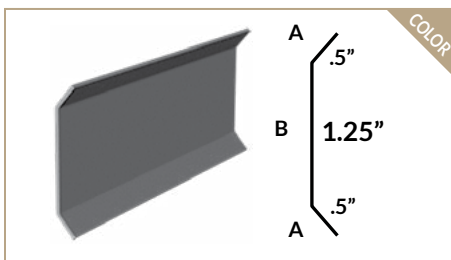

COUNTER FLASHING

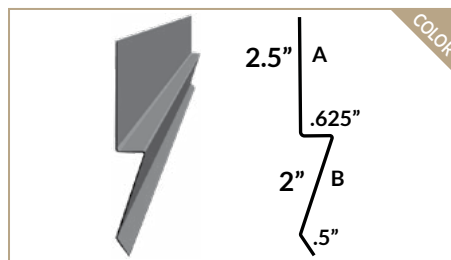

STUCCO STOP

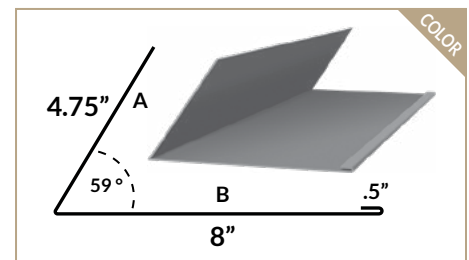

CHIMNEY FLASHING

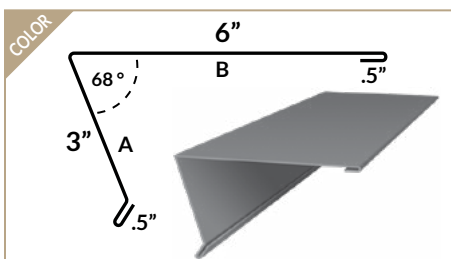

HIGH SIDE RIDGE CAP

§ OPTIONS

Please be sure to specify if a caulk edge or kerf edge is needed with sidewall or endwall trim as needed for your specific project.

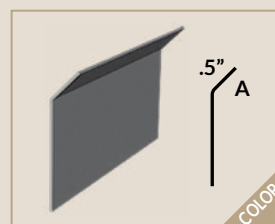

CAULK EDGE

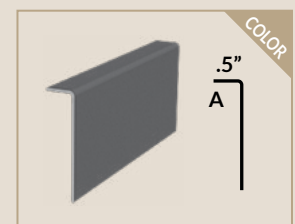

KERF EDGE

TRIM AND CLIP REFERENCE | STANDING SEAM



This page contains all the standard trim specific to the TCM-LOK, MS-LOK, and SL-LOK profiles.

- ▶ All trim sold in 10ft lengths.
- ▶ A / B Labels used for Specialty Trim custom modifications.

1" RIB HEIGHT

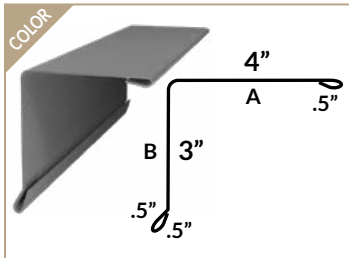

GABLE 1"

1.5" RIB HEIGHT

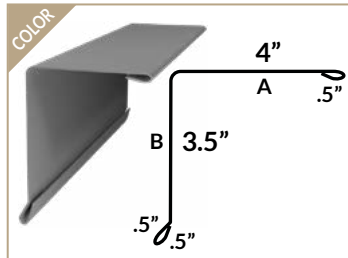

GABLE 1.5"

1.75" RIB HEIGHT

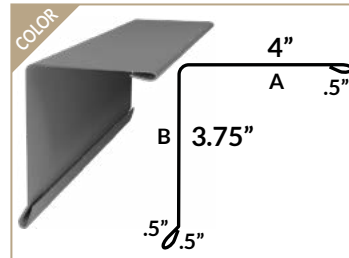

GABLE 1.75"

2" RIB HEIGHT

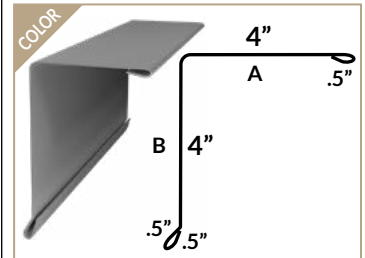

GABLE 2"

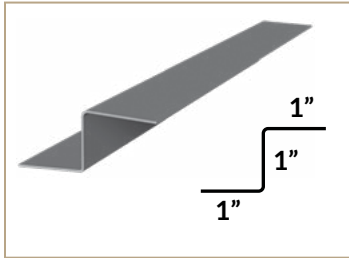

Z FLASHING 1"

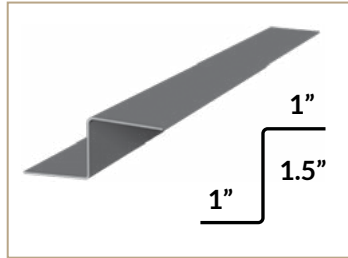

Z FLASHING 1.5"

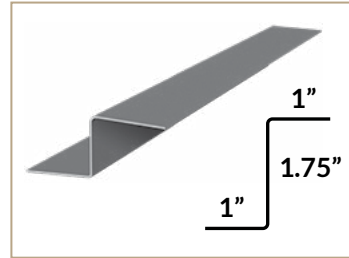

Z FLASHING 1.75"

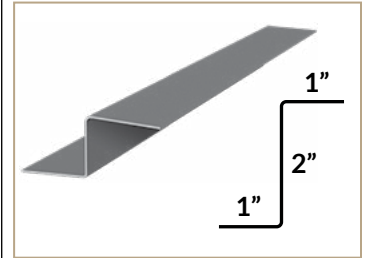

Z FLASHING 2"

ATTACHMENT METHODS

While the TCM-LOK profile has a built-in nail strip for attachment with pancake screws, MS-LOK, SL-LOK, and SS-LOK profiles require a clip for attachment. The SL-LOK and SS-LOK profiles use a standard clip, while our MS-LOK uses a "floating" clip. Also available, the TCM Continuous Clip offers greater uplift needs, and potentially faster installation.

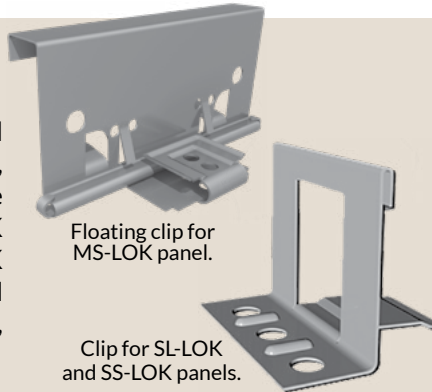

SFS BEARING PLATE

For use under any standing seam panel clip to distribute the stress of the load on the critical connections of roof panels and clips over insulation board.

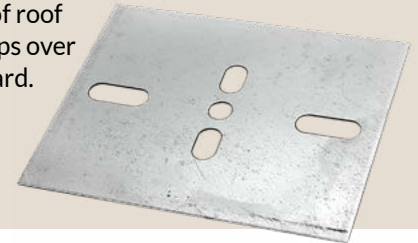

CLIPS

FOR STANDING SEAM PANELS (EXCEPT TCM-LOK)



1.5" AND 2" MS SLIDING CLIP



SL-LOK 1.5" CLIP



SL-LOK 1.75" CLIP

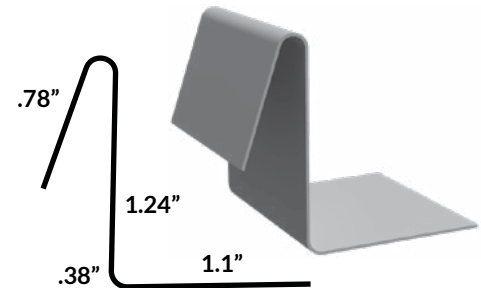

TCM CONTINUOUS CLIP

For SL-LOK panels.
Comes in 10' lengths.

Continuous clip is the strongest, simplest, most cost effective installation method for SL-LOK panels.

VENTILATION

STANDING SEAM VENTILATION ACCESSORIES

Typically Ordered Together



PROFILE VENT

Prevents water from blowing underneath the ridgecap while allowing the attic to breathe. 20' roll.



PROFILE VENT CLIP

Used to secure Profile Vent under the ridge cap.



SNAP-Z VENTING SYSTEM

Designed to fit between the ribs of standing seam roof panels. There are variations based on rib height. Offered in 26GA & .032 aluminum for all standing seam rib heights.



ATTIC BREEZE

For use with any panel type.

Attic Breeze CMA and CMD model solar attic fans offer a curb-mount flashing base for roofs featuring metal roof installations where a roof curb may be appropriate.

EXPOSED FASTENER INSULATION & VENTILATION ACCESSORIES



RADIANT BARRIER

Blocks 97% of the leading cause of heat gain in a house. 500 sq. ft. roll. Easy to install.



Be sure to also order Radiant Barrier Tape for full product benefit.



FLEX PRO

Venting material which is die cut to fit the panel profile. Used with all exposed fastener profiles. The adhesive is pre-applied for fast install. 20' roll.



FLEX-O-VENT

Prevents water from blowing underneath the ridgecap while allowing the attic to breathe. 20' roll.

WHY VENTILATION MATTERS

Metal roofs need to be ventilated to prevent condensation, which can lead to mold, mildew, and other problems. Ventilation also helps with: temperature stability, energy efficiency, and structural damage.



Attic Breeze solar attic fan installed with a 1" TCM-LOK copper color metal roofing panel.

SEALANTS

FOR USE WITH ANY PANEL TYPE



BUTYL TAPE (TACKY TAPE)

Seals laps and trim and is required on slopes less than 3:12.

Available in two sizes:
.5" x 50' .75" x 50'



Need a caulk gun?
We have them in stock!

TCM SEALANT

Adhesive / Sealant

UV Resistant. 10.3 OZ Tube fits standard caulking gun.

Available in panel colors, or clear.

NOVAFLEX SEALANT

Adhesive / Sealant

UV Resistant. 10.3 OZ Tube fits standard caulking gun.

Available in panel colors, or clear.

EXPOSED FASTENER SEALANT ACCESSORIES

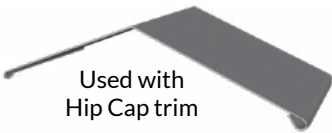

Used with Hip Cap trim



PEEL AND SEAL

Seals panels under hip caps.
6" x 33.3' rolls.



Used with W-Valley trim



EXPANDING FOAM

Prevents water from blowing underneath panels along screw line in w-valleys. 15' roll.

DIE CUT FOAM TO FIT EXPOSED PANELS

Used with Ultra Rib, PBR, and 5V panels. Sold to match panel width.



FOAM CLOSURES - INSIDE



FOAM CLOSURES - OUTSIDE



FLASHINGS

ROOF BOOTS

Used to seal around plumbing pipes, round chimneys, and weatherheads.
Available in temperature ranges: Standard (EPDM) -65 degrees to 250 degrees F,
and High Temperature Silicone -100 degrees to 450 degrees F



#3 SIZE PIPE BOOT

Color options:



#4 SIZE PIPE BOOT

Only available in gray color.



#5 SIZE PIPE BOOT

Only available in gray color.



#7 SIZE PIPE BOOT

Only available in gray color.



#9 SIZE PIPE BOOT

Only available in gray color.



HIGH TEMP

Available in sizes
#3, #4, #5, #7, and #9



Used where electric poles penetrate the roof.



ELECTRIC GRAY BOOT

Also called "RETROFIT",
installed with ZIP ties.



ELECTRIC ZIPPER SMALL



ELECTRIC ZIPPER LARGE



GOOSENECK VENTS

Available in 4", 6", and 10" sizes.



TOOLS

GENERAL TOOLS



DRILL BITS

Used for pre-drilling panels prior to fastening.
3/16" Double-sided.



MAGNETIC BIT

Used for installing fasteners.
1/4" or 5/16"



STAR BIT

Used for fastening purlin screws.
T25 Drive



TAPE MEASURE

Measures to 16th of an inch.
1" x 30'



STINGER CAP NAILER

Best practice for securing synthetic underlayments. 10 times faster than hand-drive tools. CN100 model.



TURBO SHEARS CM

Cutting of roofing panels and trim. Cuts up to 24 GA metal. Attaches to 14.4 volt or better drill.



TURBO SHEARS

Cuts up to 20 GA metal. Attaches to 14.4 volt or better drill.



6" HAND SEAMER

Used for bending and crimping.



3" HAND SEAMER

Used for bending and crimping.



Don't forget to order cap nails for your Stinger.



Order a set of Turbo Shears CM replacement blades to have on hand.

GREEN SNIPS

For cutting metal to the right.



Offset for tight right curve cuts.

RED SNIPS

For cutting metal to the left.



Regular wide right curve cuts.

YELLOW SNIPS

For cutting metal universal cuts.



Offset for tight left curve cuts.

GRXCUT633 EXAGRIP™ LATEX GLOVES – ANSI A3

15-gauge liner provides intermediate levels of cut protection.



Available in sizes M - XL

Regular wide left curve cuts.

Regular universal cuts.

STANDING SEAM TOOLS



MS 1.5" SEAMER
Single lock seamer. 1st stage.



MS 1.5" DOUBLE SEAMER
Double lock seamer. 2nd stage.



MS 2" SEAMER
Single lock seamer. 1st stage.



MS 2" DOUBLE SEAMER
Double lock seamer. 2nd stage.



RIVET TOOL
Used for installing rivets.



FOLDING TOOL
Used to fold standing seam panel ends. Bends metal up to 1.5" deep and 15.25" long. Also available in a 24" double handle version.



NEED TO RENT A POWER SEAMER?

Save time on your next installation with a power seamer rental from *D.I. Roof Sealers*. Scan the QR code below to visit the website.



CALLBACK MITIGATION

Tri County Metals carries the full line of Watts Removal Products so you can make sure your project is free of install-related blemishes and metal shavings.

Don't wait for a callback!







Learn more about Watts Removal Products on our website:



FASTENERS

Refer to FPAs for proper screw type and length requirements.
All sold in bags of 250 pieces. Available in exposed fastener colors.





WOOD ONLY

					
1/4" Head	1/4" Head	5/16" Head	5/16" Head	1/4" Head	1/4" Head
WOODGRIP	WOODGRIP XG	ZAC	ZAC XG	WOODBINDER	EVERGRIP
#9 x 1", 1.5" and 2" Galvalume Only	#12 x 1.5" and 2"	#10 x 1.5" and 2" HiLo Galvalume Only	#12 x 1.5" and 2" Galvalume Only	#9 x 1.5" and 2" Stainless Cap	#9 x 1.5" and 2" Full Stainless Only available in Stainless and White

METAL ONLY

			
5/16" Head	5/16" Head	5/16" Head	5/16" Head
TEK	LAP	ZAC TEK	ZAC LAP
#12 x 1.25"	#14 x 0.875"	#12 x 1.25" Only available in Galvalume and White	#14 x 0.875"

PANCAKE

			
REGULAR	LOW PROFILE	STAINLESS STEEL	PANCAKE TEK
#10 x 1", 1.5" and 2"	#12 x 0.75", 1", and 1.5"	#10 x 1", 1.5", and 2"	#10 x 1"

REPLACEMENT FASTENERS

 These will enlarge an existing hole, but for metal substrate there needs to be an existing fastener penetration.

WOOD OR METAL

		
#14	#14 - ZACS	#17 - ZAC
1" and 1.5" Galvalume Only	1", 1.5" and 2" Galvalume Only	Used for Strip Out fastening. 1" and 1.5" Galvalume Only

METAL ONLY

	
#14 - TEK	#14 - ZAK TEK
Used for Strip Out fastening. 1.25" Galvalume Only	Used for Strip Out fastening. 1.5" Galvalume Only



GENERAL FASTENERS



PURLIN SCREW

#9 x 3" Lifetime Screw
Star Drive
Used for attaching 1 x 4's to roof
2000 per box



TRIM NAILS

1lb box
Flat Head, 1.25" long
Used for fastening drip edge



UNDERLAYMENT NAILS

1.25" (2000 per box)



RIVETS

0.125" Stainless and Painted
Stainless Rivets - 100/bag



STINGER NAIL DRUM

Electro Galvanized 1" NailPac for use
with the STINGER CN100B or
CN100 only



COLLATED AND STICK NAILS

(for Purlins)
Each item is 2.375" length and comes in 5,000 qty

UNDERLAYMENTS, PURLINS, AND DOORS



PEEL AND STICK

2 Square Roll 36" wide x 66.8' long
High Temp, 90 day Exposure
and 10 year warranty



SYNTHETIC HT UNDERLAYMENT

100% Synthetic Material
10 Square Roll
25 Year Warranty to Shed Water
6 month UV Resistant



1 X 4 X 12 SYP WOOD PURLINS

Used for roof-overs



ROLL-UP DOOR

Order any Size You Need
Many Colors to Choose From
Many Options Can be Added
7-14 Day Lead Time
Perfect for Workshops, Barns and Sheds

FASTENERS AVAILABLE DIRECT FROM TRI-COUNTY METALS

Part Name	Description	Stock / Non-Stock	Material	Replacement Recommendation
1 WOODGRIPS	1 WOODGRIPS	Stock	Wood	#12XG Fastener
1.5 WOODGRIPS	1.5 WOODGRIPS	Stock	Wood	#12XG Fastener
2 WOODGRIPS	2 WOODGRIPS	Stock	Wood	#12XG Fastener
2.5 WOODGRIPS	2.5 WOODGRIPS	Stock Galv only	Wood	#12XG Fastener
1 WOODZAC	1 ZACS (Galvalume)	Stock Galv only	Wood	#12XG Fastener
1.5 WOODZACS	1.5 WOODZACS	Stock	Wood	#12XG Fastener
2 WOODZACS	2 WOODZACS	Stock	Wood	#12XG Fastener
2.5 WOODZACS	2.5 WOODZACS	Stock Galv only	Wood	#12XG Fastener
#12-1 XG	#12-1 XG	Stock	Wood	#14 Fastener
#12-1.5 XG	#12-1.5 XG	Stock	Wood	#14 Fastener
#12-2 XG	#12-2 XG	Stock	Wood	#14 Fastener
#12-2.5 XG	#12-2.5 XG (Galvalume)	Non Stock	Wood	#14 Fastener
#12-1.5 ZAC XG	#12-1.5 ZAC XG	Stock	Wood	#14 Fastener
#12-2 ZAC XG	#12-2 ZAC XG	Stock	Wood	#14 Fastener
#12-2.5 ZAC XG	#12-2.5 ZAC XG (Galvalume)	Stock Galv only	Wood	#14 Fastener
1.5 SS WOODBINDER MB	1.5 SS WOODBINDER MB	Stock	Wood	#12 SCAMP Fastener (Special Order)
2 SS WOODBINDER MB	2 SS WOODBINDER MB	Stock	Wood	#12 SCAMP Fastener (Special Order)
1.5 EVERGRIPS	1.5 EVERGRIPS (Galvalume)	Stock Galv and White	Wood	#14 Full Stainless Fastener
1.5 EVERGRIPS	1.5 EVERGRIPS (Polar White)	Stock Galv and White	Wood	#14 Full Stainless Fastener
2 EVERGRIPS	2 EVERGRIPS (Galvalume)	Stock Galv and White	Wood	#14 Full Stainless Fastener
2 EVERGRIPS	2 EVERGRIPS (Polar White)	Stock Galv and White	Wood	#14 Full Stainless Fastener
LAP Screws	LAP Screws	Stock	Metal	#17 Self Tapping Fastener
TEK SCREW	TEK SCREW	Stock	Metal	#14 Self Tapping Fastener
TEK Screws #14	#14 OVERSIZED TEKS Screws (Galvalume) 1/4-14 X 1-1/4"	Stock Galv only	Metal	#17 Self Tapping Fastener
ZAC LAP	ZAC LAP	Stock	Metal	#17 Self Tapping Fastener
ZAC TEK Screws	ZAC TEKS Screws (Galvalume) 12 X1 1/4	Stock Galv and White	Metal	#14 Self Tapping Fastener
ZAC TEK Screws	ZAC TEKS Screws (Polar White) 12-14 X1 1/4	Stock Galv and White	Metal	#14 Self Tapping Fastener
#14 ZAC TEK	OVERSIZED ZAC TEKS Screws (Galvalume) #14 X1-1/2	Stock Galv only	Metal	#17 Fastener
#14-1	#14-1 TYPE A-MP POINT (Galvalume)	Stock Galv only	Wood	#17 Fastener
#14-1.5	"#14-1.5 TYPE A-MP POINT (Galvalume)	Stock Galv only	Wood	#17 Fastener
#14-1.5 WOODZACS	#14 x 1.5 ZACS (Galvalume)	Stock Galv only	Both	#17 Fastener
#14-2 WOODZACS	#14 x 2 ZACS (Galvalume)	Stock Galv only	Both	#17 Fastener
#14-2.5 WOODZACS	#14 x 2.5 ZACS (Galvalume)	Stock Galv only	Both	#17 Fastener
#17-1 ZAC	STRIP OUT #17 x 1 ZACS (Galvalume)	Stock Galv only	Metal	#21 Fastener (Special Order)
#17-1.5 ZAC	STRIP OUT #17 x 1.5 ZACS (Galvalume)	Stock Galv only	Metal	#21 Fastener (Special Order)

Part Name	Description	Stock / Non-Stock
BACKER ROD	Backer Rod 3/8in. Closed Cell Foam Backer Rod - 2100LF	Stock
ELECTRIC BOOT GRAY	ELECTRIC PIPE BOOT GRAY #1 SQUARE BASE RETROFIT 1/2 - 4 (with zip tie)	Stock
ELECTRIC ZIPPER	ELECTRIC ZIPPER PIPE BOOT GRAY 2 - 7 1/4	Stock
ELECTRIC ZIPPER SM	ELECTRIC ZIPPER PIPE BOOT GRAY 3/4 - 2 3/4	Stock
GOOSENECK BOOT	GOOSENECK ROOF VENT SEALING ADAPTER GREY 4.375 to 16.75	Stock
PANCAKE Screw 10-1	#10 x 1 PANCAKE TYPE A	Stock
PANCAKE Screw 10-1.5	#10 x 1.5 PANCAKE TYPE A	Stock
PANCAKE Screw 10-2	#10 x 2 PANCAKE TYPE A	Stock
PANCAKE Screw 12 - 3/4 LOW PROFILE	#12 x 3/4 PANCAKE XG LOW PROFILE	Stock
PANCAKE Screw 12-1 LOW PROFILE	#12 x 1 PANCAKE XG ++LOW PROFILE++	Stock
PANCAKE Screw 12-1.5 XG	#12 x 1.5 PANCAKE XG	Stock
PANCAKE Screw STAINLESS 1	STAINLESS PANCAKE Screw #10 x 1	Stock
PANCAKE Screw STAINLESS 1.5	STAINLESS PANCAKE Screw #10 x 1.5	Stock
PANCAKE Screw STAINLESS 2	STAINLESS PANCAKE Screw #10 x 2	Stock
PANCAKE TEK Screw 10-1	#10-16 X 1" Pancake self drill -SD2	Stock
SS 1.5 MS LOK SLIDING CLIP	MS LOK 1.5 IN SLIDING CLIP 2-HOLE NEWTECH	Stock
SS 1.5 MS LOK SLIDING CLIP STAINLESS	STAINLESS STEEL MS LOK 1.5 IN SLIDING CLIP 2-HOLE NEWTECH	Stock
SS 1.5 SL CLIP	SL LOK 1.5 SNAP LOCK CLIP 3-HOLE	Stock
SS 1.5 SL CLIP STAINLESS	STAINLESS STEEL SL LOK 1.5 SNAP LOCK CLIP 3-HOLE	Stock
SS 1.75 CLIP	SS LOK 1.75 SNAP LOCK CLIP 2-HOLE	Stock
SS 1.75 CLIP STAINLESS	STAINLESS STEEL SS LOK 1.75 SNAP LOCK CLIP 2-HOLE	Stock
SS 2 IN SLIDING CLIP	MS LOK 2 IN SLIDING CLIP 2-HOLE NEWTECH	Stock
SS 2 IN SLIDING CLIP STAINLESS	STAINLESS STEEL MS LOK 2 IN SLIDING CLIP 2-HOLE NEWTECH	Stock

Complete this order form and forward to customerexperience@tricountymetals.com,
or visit store.tricountymetals.com to place your order.



Please select: Quote Request Order **Need help ordering? Give us a call 877-766-3309**

Name: _____ Phone: _____

Address: _____

Email: _____ Job Name: _____

Pickup Location: _____

Delivery Location: _____

5V Gauge: _____ Color: _____
 Ultra-Rib Gauge: _____ Color: _____
 PBR Gauge: _____ Color: _____
 TCM-Lok Gauge: _____ Color: _____
 SL-Lok Gauge: _____ Color: _____
 MS-Lok Gauge: _____ Color: _____

Panels

Enter Panel Sizes		
Quantity	Feet	Inches

INSULATION/VENTILATION	QTY
TCM Radiant Barrier	
TCM Radiant Tape	
FlexPro	
Snap Z	

SEALANTS	QTY
Peel and Seal	
TCM Sealant	
Expanding Foam	
Butyl	
Inside Closures	
Outside Closures	

UNDERLAYMENTS/PURLINS	QTY
Ultra HT Wind & Water	
Synthetic HT Underlayment	
1 x 4 x 12 SYP	

TRIM	QTY
Drip Edge	
Ridge Cap	
Flat Ridge Cap	
Hip Cap	
Gable Rake	
W-Valley	
Sidewall	
Endwall	
Flat Endwall	
Transition Flashing	
Chimney Flashing	
Panel Starter	
Z-Flashing	
Eave Cleat	

FASTENERS	Woodgrip Screw QTY	Wood Binder QTY	WoodZac QTY	Woodgrip XG QTY
1"				
1 1/2"				
2"				
Pancakes				
Tek Screws				
Lap Screws				

Notes:

FLASHINGS	QTY Standard	QTY HighTemp
RoofBoots		
#3: 1/4" - 5" Color:		
#4: 5" - 6.75"		
#5: 4 1/4" - 7 1/2"		
#7: 6" - 11"		
#9: 9" - 19"		
Electric Pipe Boot		
Touch Up Paint Pen		
Spray Paint		
Gooseneck Vents		

FASTENERS	QTY
Stainless Rivets	
Painted Rivets	
Purlin Screws #9 x 3"	
Collated Nails	
Stick Nails	
Trim Nails 1-1/4"	
Felt Nails 1 1/4"	
Stinger Nails	

Please sketch out your trim and include clear dimension measurements, pitch needed / degrees of each angle needed, and an arrow to help the fabricator know on what side the paint color needs to be oriented.

Specialty Trim 1
(attach drawing or draw in box)

QTY: ____ Ga: ____ Color: _____ Stretched Out: _____

Specialty Trim 2
(attach drawing or draw in box)

QTY: ____ Ga: ____ Color: _____ Stretched Out: _____

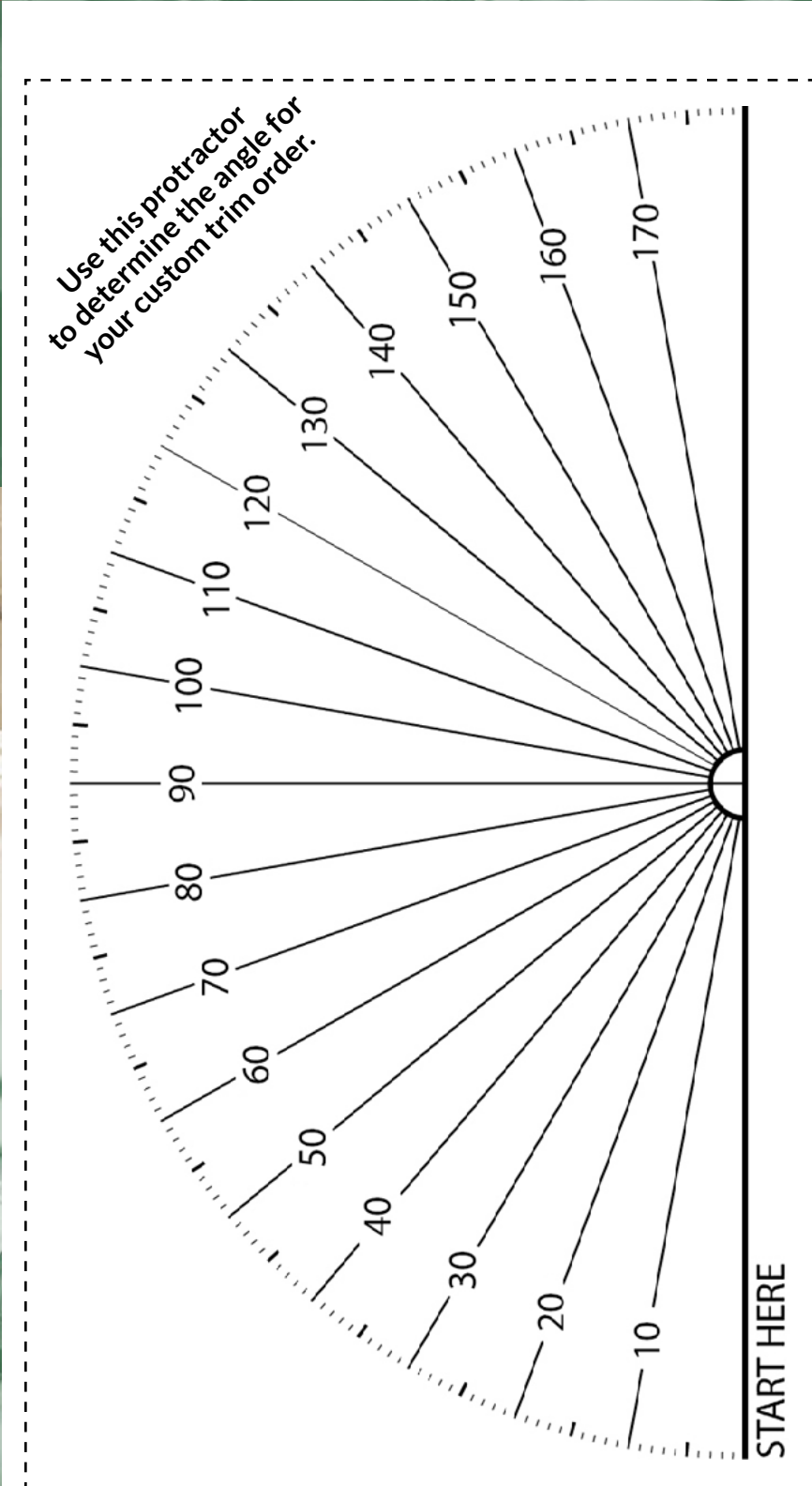



**DON'T HESITATE
TO CONTACT US.**

Locations open Monday - Friday,
7:30 am until 4:30 pm*
Customer Experience 877-766-3309
TriCountyMetals.com

TRENTON

301 SE 16th St. Trenton, FL 32693
Phone: 352-463-8400
Email: Trenton@TriCountyMetals.com

LIVE OAK

10142 SW 90th Trail, Live Oak, FL 32060
Phone: 386-330-0101
Email: LiveOak@TriCountyMetals.com

OCALA

3021 NW Blichton Rd., Ocala, FL 34475
Phone: 352-622-5500
Email: Ocala@TriCountyMetals.com

TALLAHASSEE

3708 NW Passage, Tallahassee, FL 32303
Phone: 850-574-4001
Email: Tallahassee@TriCountyMetals.com

BROOKSVILLE

922 Ponce DeLeon Blvd, Brooksville, FL 34601
Phone: 352-587-8120
Email: Brooksville@TriCountyMetals.com

DELAND

1721 Langley Ave., Deland, FL 32724
Phone: 386-738-2579
Email: Deland@TriCountyMetals.com

JACKSONVILLE

4255 Dignan St., Jacksonville, FL 32254
Phone: 904-490-6004
Email: Jacksonville@TriCountyMetals.com

WINTER HAVEN

5577 East CR 542, Winter Haven, FL 33880
Phone: 863-377-2805
Email: WinterHaven@TriCountyMetals.com

OKEECHOBEE*

4173 NE 80th Ave., Okeechobee, FL 34972
Phone: 863-261-8411
Email: Okeechobee@TriCountyMetals.com

*Note: This location is open 8 am to 4:30 pm, M-F

*Use this protractor
to determine the angle for
your custom trim order.*

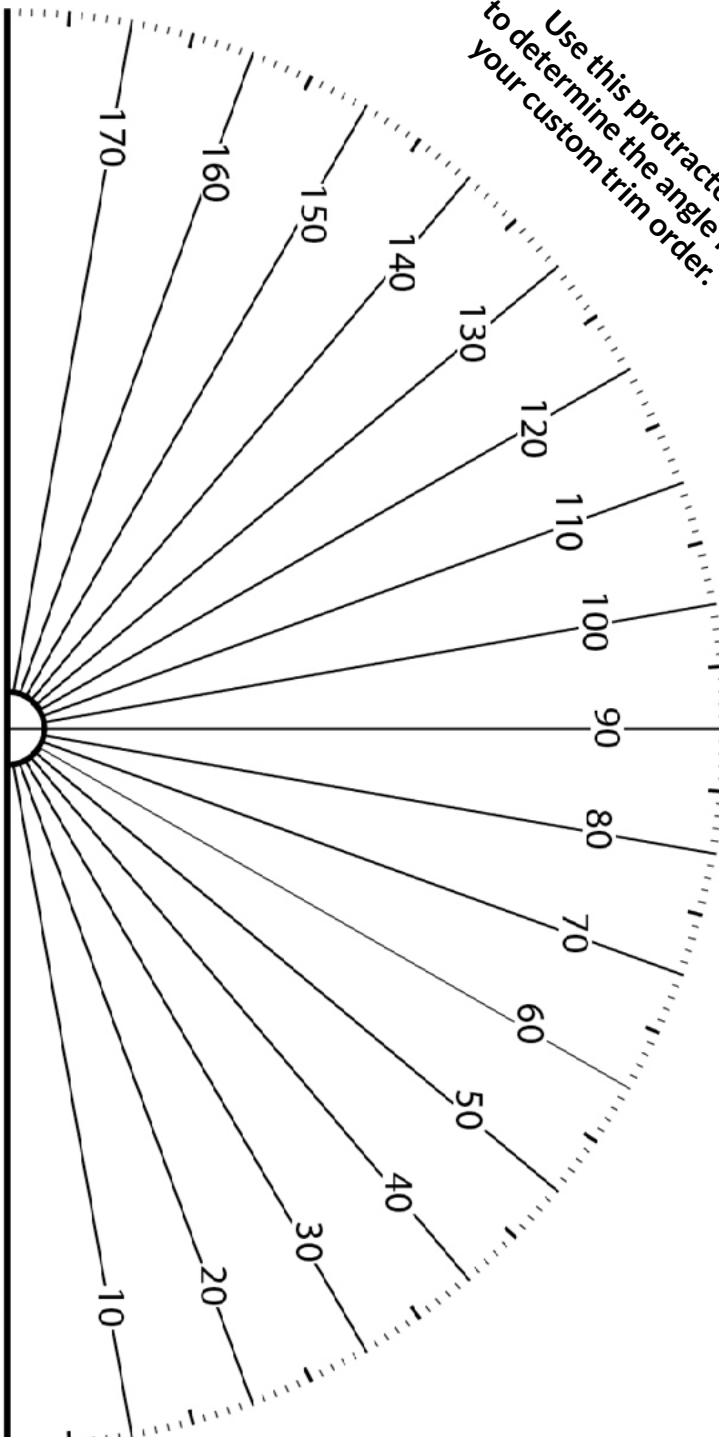

START HERE